

Professional Economic Lighting Led system



ULEE

The assurance of better quality

ATLAS Series 1M

SOLAR STREET LIGHT



INTRODUCTION

Product specifications

- 01 FRONT COVER
- 02 CATALOG
- 03 MAIN ADVANTAGES
- 04 SPECIFICATIONS
- 05 OPTICAL FIGURE
- 06 DIMENTION FIGURE
- 07 LIGHT POLE DIAGRAM
- 08 LIGHT POLE DIAGRAM
- 09 MORE DETAILS
- 10 CORE TECHNOLOGY
- 11 INSTALLATION INSTRUCTIONS
- 12 PACKAGE DETAIL
- 13 APPLICATION

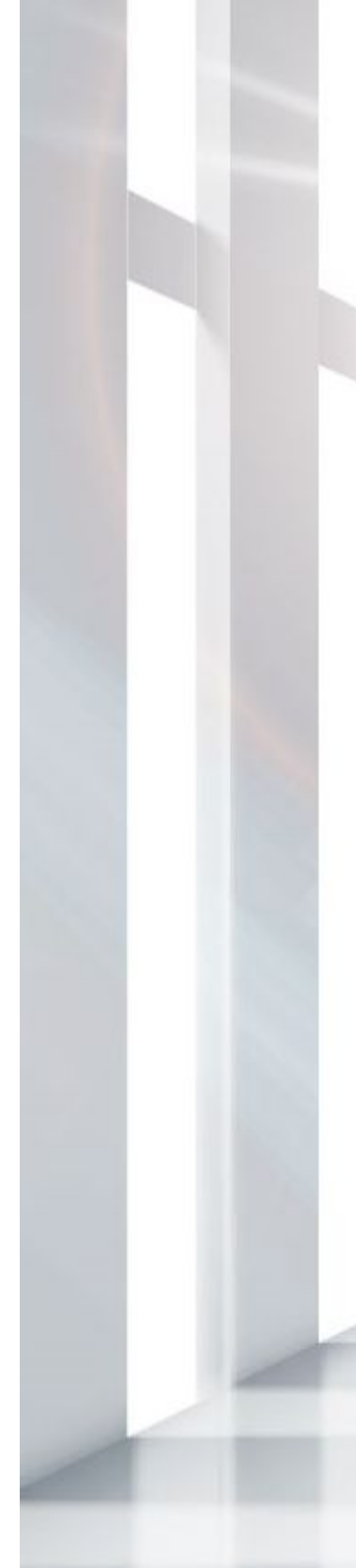

ULEE



10 CLOUDY DAYS STILL LIGHTING

BMS technology speeds up the battery charging over 30%;
Never stop lighting with New HI-technology-ALS 2.3 Up to 10
rainy or cloudy days
Powerful Lithium battery with 1500 cycles, widely used in
new-energy car;
4 Intelligent Core Technology broke the bottleneck of short
working time of solar lights in rainy/cloudy days, and realized
100% lighting throughout the year
Each part can be replaced on the pole directly, save
maintenance costs

ATLAS 1M SERIES



Item : ATLAS 1M	SSL-32M	SSL-33M	SSL-34M	SSL-35M	SSL-36M	SSL-37M	SSL-38M	SSL-39M	SSL-310M
Light Brightness	2000LM	3000LM	4000LM	5000LM	6000LM	7000LM	8000LM	9000LM	10000LM
Solar panel									
Power	25W	37.5W	37.5W	60W	60W	60W	75W	75W	75W
Li-ion battery									
Capacity	14.8V 153.92WH 2.6AH/PCS S	14.8V 192.4WH 2.6AH/PCS	14.8V 269.36WH 2.6AH/PCS	14.8V 346.32WH 2.6AH/PCS	14.8V 423.28WH 2.6AH/PCS	14.8V 500.24WH 2.6AH/PCS	14.8V 577.2WH 2.6AH/PCS	14.8V 615.68WH 2.6AH/PCS	14.8V 692.64WH 2.6AH/PCS
Charging/Discharging Temp	0~45°C / -20~60°C								
Charging Time	6H	5H	7H	6H	7H	9H	8H	9H	10H
LED (OSRAM)	3030 20pcs ;	3030 40pcs	3030 40pcs	3030 80pcs	3030 80pcs	3030 80pcs	3030 160pcs	3030 160pcs	3030 160pcs
Color Temp	5700K , Ra 70+	5700K , Ra 70+	5700K , Ra 70+	5700K , Ra 70+	5700K , Ra 70+	5700K , Ra 70+	5700K , Ra 70+	5700K , Ra 70+	5700K , Ra 70+
Efficiency	190lm/W	190lm/W	190lm/W	190lm/W	190lm/W	190lm/W	190lm/W	190lm/W	190lm/W
Performance									
Lighting Time in Rainyday	>10 Days								
Control Mode	Button Switch , ON/OFF Long Press 1.5s								
Lighting Mode	M1 : 30%+PIR / M2 : 100%(5H)+25%(PIR)(5H)+70% / M3:70% Till dawn								
Mode Indication	M1: red light, M2: green light, M3 orange light (press the button to switch between M1 (red) /M2 (green) /M3 (orange); 5S after mode indicates is power indicator								
Capacity Indication	Green : ≥70% ; Orange : 30%~70% ; Red : < 30%								
PIR	120° , >5m								
Core technology	ALS 2.3 / TCS 1.0								
Solar Panel Autoclean	-								
IP/IK Class	IP65 / IK10								
Install Height / Distance	3m /10m	3m / 15m	4m / 15m	5m / 15m	6m / 22m	7m / 28m	8m / 28m	9m / 32m	10m / 32m

SSL-32M/33M/34M

Road Simulated Diagram

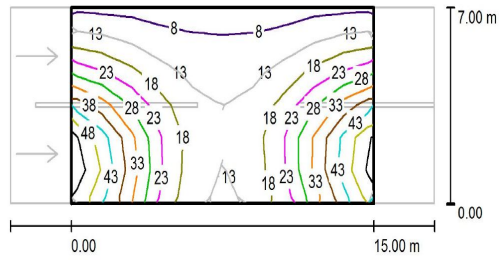

Illumination Curve

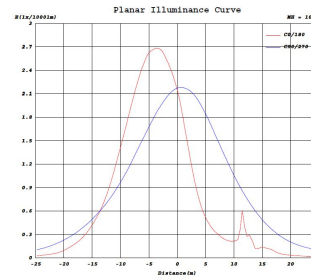

Luminance Distribution

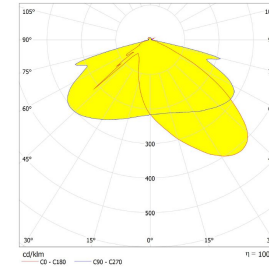

SSL-35M/36M/37M/38M/39M/310M

Road Simulated Diagram

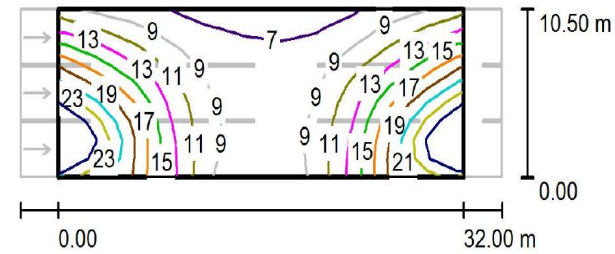

Illumination Curve

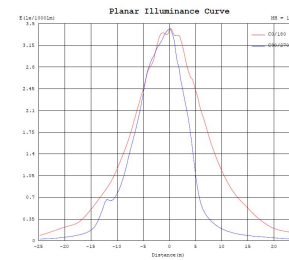

Luminance Distribution

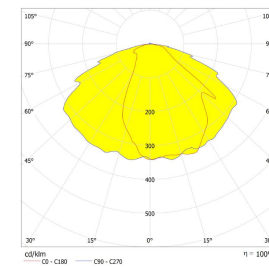

SOLAR LIGHT | DIMENTION FIGURE

SSL-38M/39M/310M

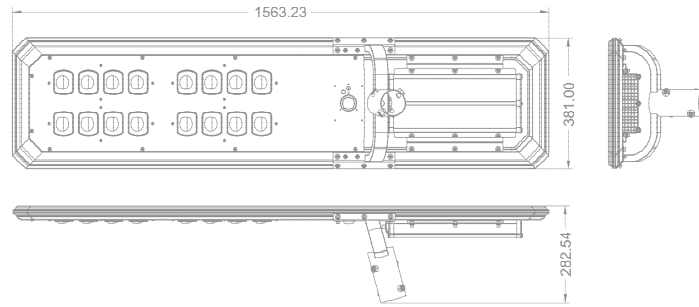

SSL-35M/36M/37M

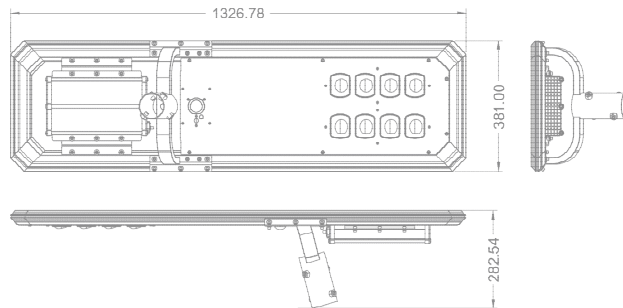

SSL-33M/34M

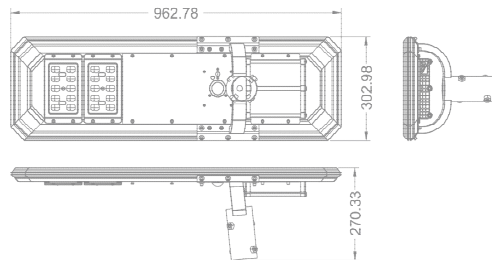

SSL-32M

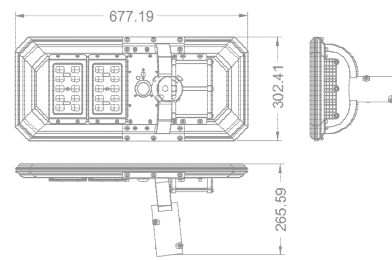





Advantage in every detail

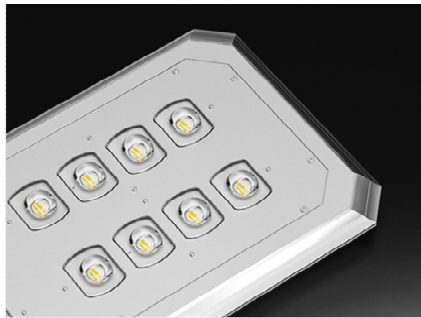
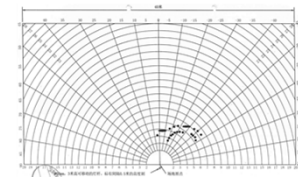

High Lumen LEDs
190lm/W

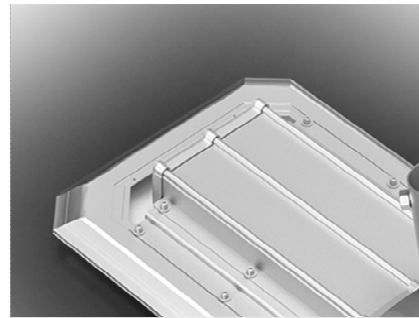

Battery Pack
Easy to Maintain

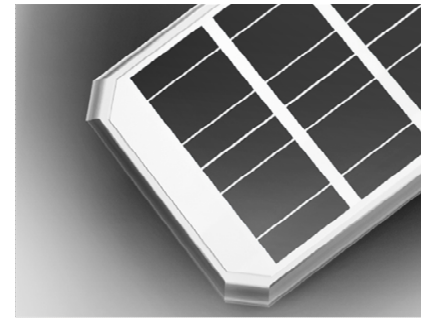

Monocrystalline
Solar Charging Efficiency :>21%



High Lumen LEDs
190lm/W



Bracket
Double Protection for Rust-Proof



High Sensitivity PIR Sensor



A Great Company should always pay the highest attention to the every detail design , and the craftsmanship spirit should be filled in the whole design process and mass production.

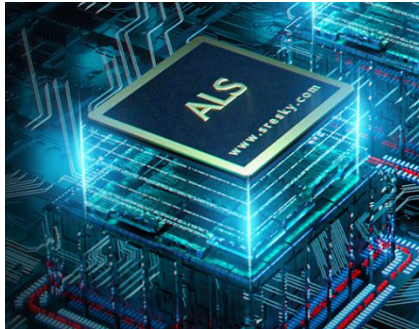

ADVANTAGE OF ALS

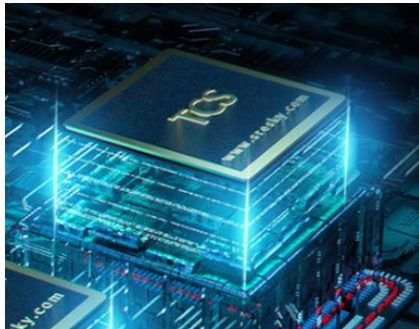
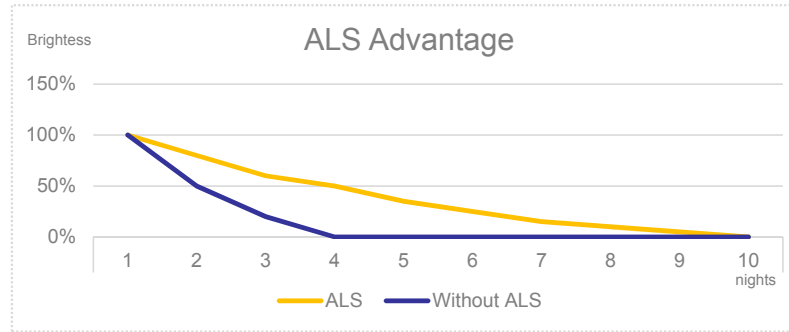

ADVANTAGE OF TCS

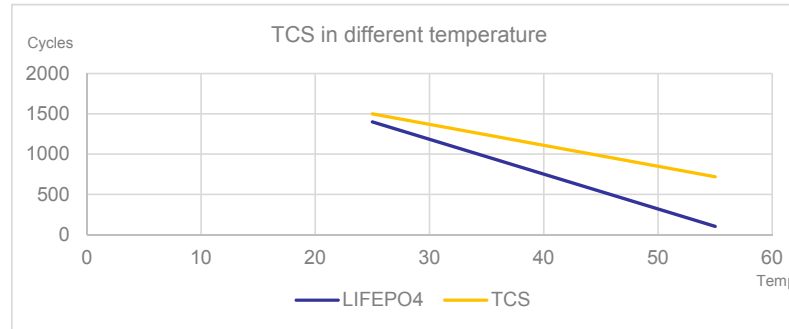

- 1 Dig a hole according to the size of the foundation cage, put the foundation cage into the hole and fix it with concrete C20.

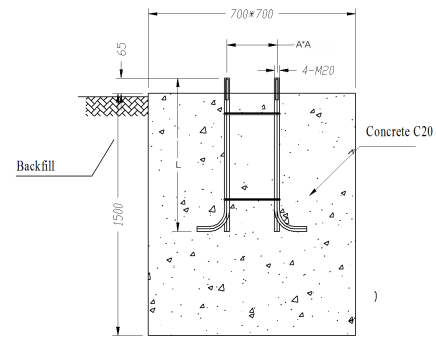

- 2 Use the supplied screws to fix the bracket on the lamp.

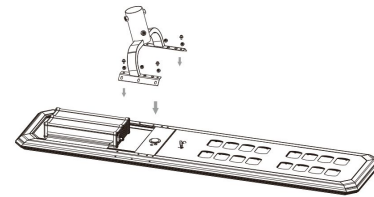

- 3 Use the supplied screws to fix the lamp on the pole.

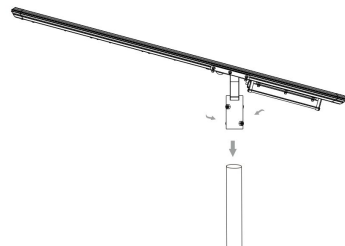

- 4 Lift the lamp pole by the person or machine, align the bottom flange of the lamp pole with the foundation cage, and then fix the lamp pole with screws.

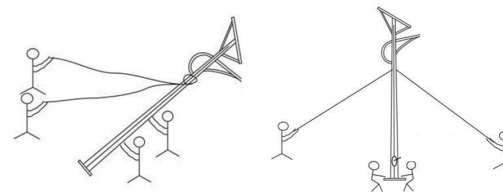

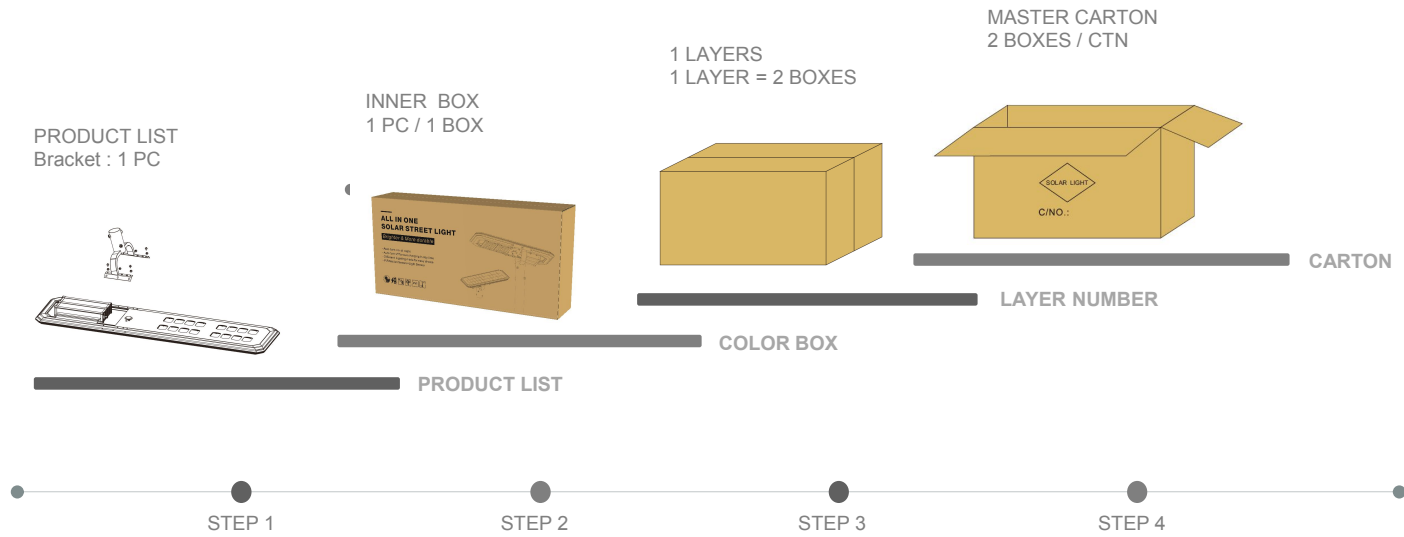

MODEL NO.	PACKING METHOD	PCS/CTN	QTY(PCS)	CTN QTY	CARTON SIZE(CM)	N.W.(KG)	G.W.(KG)
SSL-32M	Solar Light	2	2	1	77.5*32.9*39.8	12.5	13.5
	Bracket	2	2	1	33.0*21.5*28.0	2.3	3
SSL-33M/34M	Solar Light	2	2	1	106.0*32.9*39.8	14.5	18.7
	Bracket	2	2	1	33.0*21.5*28.0	2.3	2.9
SSL-35M/36M/37M	Solar Light	2	2	1	144*37*49.5	28.8	30.8
	Bracket	2	2	1	41*21*28	2.9	3.3
SSL-38M/39M/310M	Solar Light	2	2	1	167.5*38.0*49.5	38	40
	Bracket	2	2	1	41*21*28	2.9	3.3

Net weight and gross weight are for reference only

S / O / L / A / R / L / I / G / H / T

ULEE INTERNATIONAL (H.K.) LIMITED